

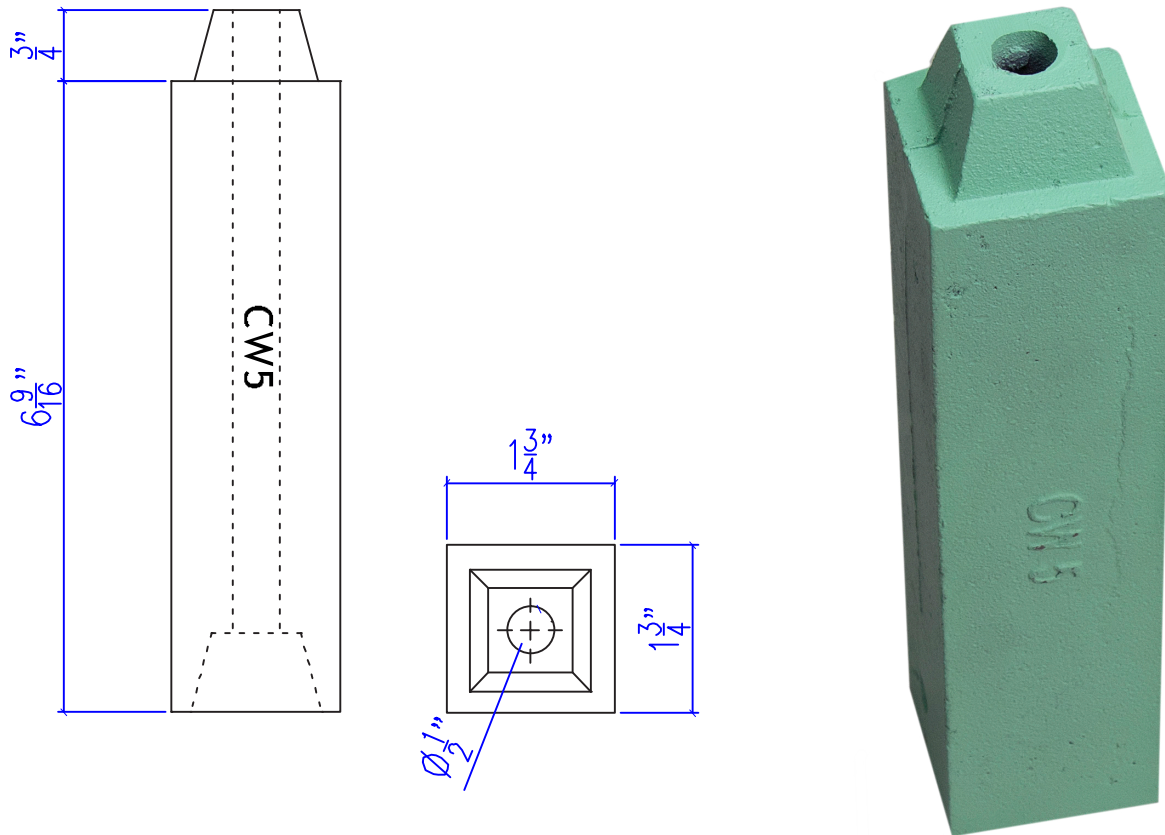

CW 5 STACKABLE SASH WEIGHT



Scale 1:2

CW5 Stackable Sash Weight

SRS offers stackable cast iron sash weights in 1, 3 and 5 pound increments. The stackable feature allows you to easily optimize the weights to match sash weight with minimal waste. The 1-3/4" square cross section allows for the greatest weight in a given weight pocket (critical when used with heavy, wide or insulated units.)